

ORBITAL SOSPENSIONE

elcom
ARCHITECTURAL

Istruzioni di montaggio

Installation instructions

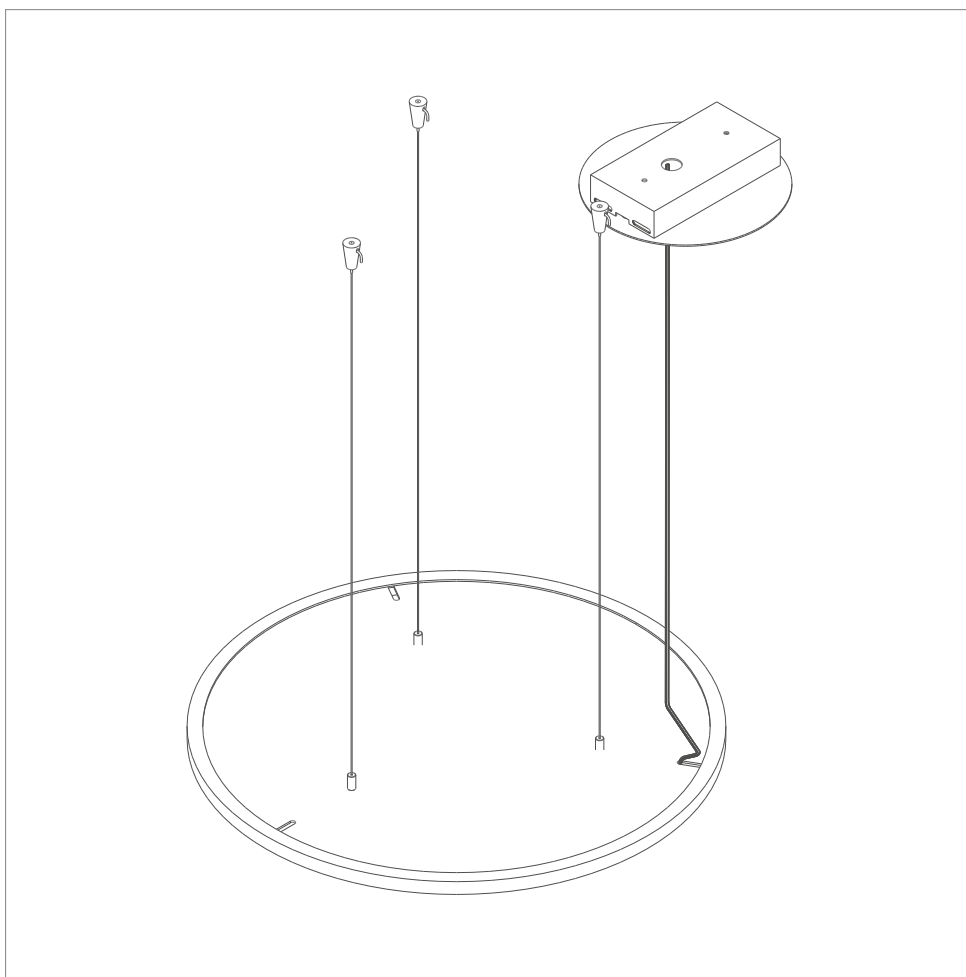

ELCOM srl

Via Ugo la Malfa 5, 25030 Castel Mella (BS) - ITALIA
Tel. 0039 030 6830559

Elcomarchitectural.com
info@elcomsrl.net

ISTRUZIONI D'USO

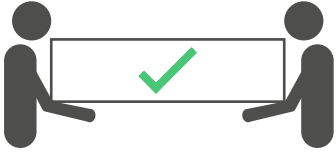

TRASPORTARE SEMPRE IN COSTA
ALWAYS CARRY VERTICALLY

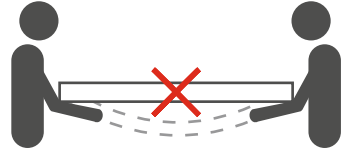

EVITARE L'IMBARCAMENTO
AVOID BENDING OR CURVING



NON UTILIZZARE VENTOSE
DON'T USE SUCTION CUP LIFTERS



NON SCHIACCIARE IL PANNELLO
DO NOT CRUSH THE PANEL

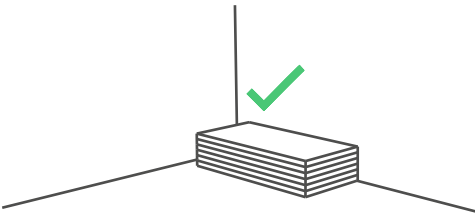

APPOGGIARE ORIZZONTALMENTE
LAY HORIZONTALLY

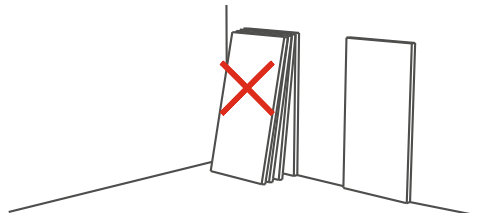

NON APPOGGIARE VERTICALMENTE
DON'T LAY VERTICALLY



NON CALPESTARE
DON'T STEP ON

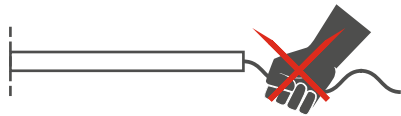

NON TIRARE O DANNEGGIARE I CAVI
DO NOT PULL OR DAMAGE THE CABLES

INSTRUCTIONS FOR USE

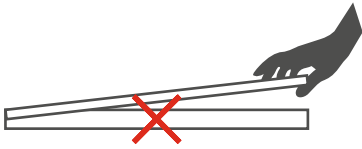

NON APRIRE IL PANNELLO
DO NOT OPEN THE PANEL

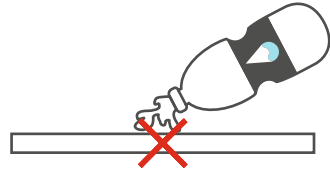

NON BAGNARE
DO NOT SOAK



NON FORARE
DO NOT DRILL

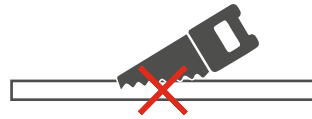

NON TAGLIARE
DO NOT CUT



AVVERTENZE



TOGLIERE LA TENSIONE PRIMA DI EFFETTUARE QUALSIASI TIPO DI MANUTENZIONE.



L'APPARECCHIO DEVE ESSERE INSTALLATO SOLO DA PERSONALE QUALIFICATO, NEL RISPETTO DELLE NORME D'INSTALLAZIONE NAZIONALI (MERCATO ITALIA LEGGE 46/90). L'AZIENDA DECLINA OGNI RESPONSABILITÀ QUALORA L'INSTALLAZIONE NON AVVENGA SECONDO LE NORME VIGENTI. LASCIARE COPIA DI QUESTE ISTRUZIONI AL RESPONSABILE DELLA MANUTENZIONE.



ATTENZIONE !

- La sicurezza di questo apparecchio è garantita solo dopo la consultazione ed il rispetto di queste istruzioni in fase di installazione e di utilizzo, pertanto è necessario conservarle.

AVVERTENZE:

- Prima di ogni operazione sull'apparecchio disinserire la tensione di rete.
- L'apparecchio non può essere in alcun modo modificato o manomesso, causa decadimento della garanzia.
- Ogni modifica potrebbe compromettere la sicurezza dell'apparecchio rendendolo pericoloso.
- Qualsiasi riparazione deve essere effettuata dalla ditta produttrice.
- La ditta produttrice declina ogni responsabilità per tutti i prodotti modificati.
- Questo apparecchio è dotato di sorgente luminosa LED ed è stato testato secondo la normativa IEC 62471 e IEC/TR 62778 vigenti (sicurezza fotobiologica delle lampade).
- La sorgente luminosa non può essere sostituita dal cliente. Per informazioni contattare la ditta produttrice.
- L'apparecchio non deve essere installato in ambienti umidi.
- L'apparecchio acceso non deve essere coperto da nessun materiale.
- L'apparecchio non è adatto all'utilizzo da parte dei bambini.



ISTRUZIONI PER LA PULIZIA DELL'APPARECCHIO:

- Assicurarsi di aver scollegato la spina dalla presa elettrica prima di iniziare la pulizia.
- Non immergere mai l'apparecchio, il cavo di alimentazione e la spina di corrente nell'acqua o altri liquidi.
- Utilizzare esclusivamente un panno morbido
- Non utilizzare alcool, solventi, acidi, sgrassatori
- Non versare liquidi sull'apparecchio.



SMALTIMENTO:

- Smaltire separatamente questo prodotto consente di evitare possibili conseguenze negative per l'ambiente e per la salute. L'utente finale è responsabile della consegna dell'apparecchio, a fine vita, alle appropriate strutture di raccolta. Eventuali inadempienze sono soggette a sanzioni secondo le disposizioni nazionali vigenti. Per informazioni dettagliate riguardo i sistemi e le modalità di raccolta vi invitiamo a contattare l'ufficio preposto nella vostra città per il servizio locale di smaltimento rifiuti elettrici.



WARNINGS



TURN OFF THE VOLTAGE BEFORE PERFORMING ANY TYPE OF MAINTENANCE.



THE FIXTURE MUST BE INSTALLED EXCLUSIVELY BY QUALIFIED PERSONNEL. THE COMPANY DENIES ANY LIABILITY IN CASE INSTALLATION IS NOT CARRIED OUT IN COMPLIANCE WITH CURRENT LAWS.

LEAVE COPY OF THESE INSTRUCTIONS TO MAINTENENCE PERSONNEL IN CHARGE.



ATTENTION!

The security of this device is only guaranteed after consulting and respecting these installation and usage instructions. For this reason, it is necessary to save it.

WARNINGS:

- Prior to any work on the fixture always switch off the mains.
- The device can't be modified or rigged in any way. In that case the warranty will be lost.
- Every modification could affect the security of the device, making it dangerous.
- Any reparation must be done by the manufacturer.
- The manufacturer accepts no responsibility over modified device.
- This device is equipped with a LED light source and it has been tested according to the existing regulations IEC 62471 and IEC/TR 62778 (photobiological safety of lamps).
- The light source can't be replaced by the costumer itself. For more information, please, contact the manufacturer.
- The device can't be installed in damp environments.
- Do not cover the device with any material, when turned on.
- The device is not suitable for being used by children.



DEVICE CLEANING INSTRUCTIONS:

- Be sure to unplug the device before you start cleaning.
- Do not immerse the device, the power supply cable and the plug in water or any other liquid.
- Only use a soft cloth to clean the device.
- Do not use alcohol, solvent, acid or degreaser.
- Do not pour liquids on the device.



DISPOSAL:

- Disposal of this product separately avoids possible negative consequences for the environment and health. The end user is responsible for the delivery of the appliance at the end of its life to the appropriate collection facilities. Any non-compliance shall be subject to penalties in accordance with the national provisions in force. For detailed information on collection systems and methods please contact the local electrical waste disposal office in your city.

SPECIFICHE - SPECIFICATIONS

I modelli **SENZA ALIMENTATORE (cod. NC)** sono a 24 Vdc Classe III.
 The "WITHOUT POWER SUPPLY" models (Code NC) are 24 Vdc Class III.

24
VDC



Model: **ON/OFF / DALI / 1...10V/PUSH**

220
VAC



Ø516 mm
(spessore 20 mm)

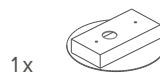

Ø707 mm
(spessore 20 mm)

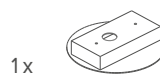

Ø899 mm
(spessore 20 mm)

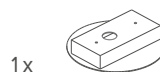

Ø1216 mm
(spessore 20 mm)



N.B: N°3 Sospensione = 3 Cavi + 3 Agganci a cilindro per sospensioni + 3 nottolino.

N.B: N°3 Suspension = 3 Cables + 3 Cylindrical attachments for suspensions + 3 nuts.



MORSETTI

NON INCLUSI: Per tutti i modelli (ON/OFF, DALI, 1...10V/PUSH, NC)

Not included: For all models (ON/OFF, DALI, 1...10V/PUSH, NC)

1

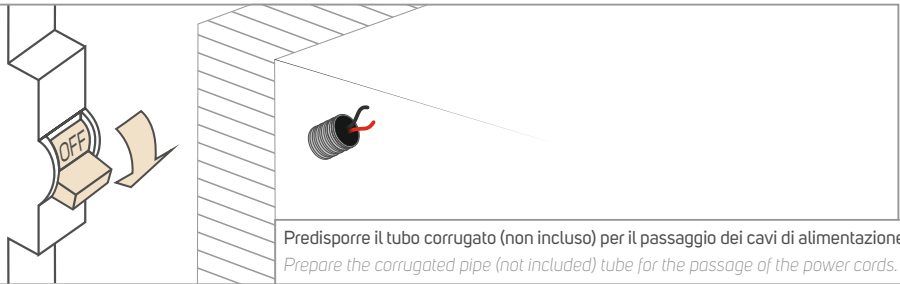

2

Misure in mm
 Measures in mm

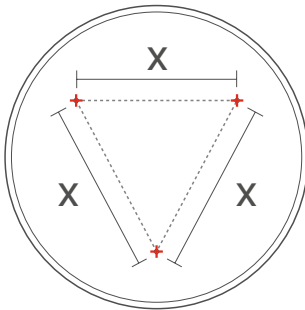

Modello	X
Ø516	245
Ø707	337
Ø899	429
Ø1216	580

Misura interasse dei fori indicativa, controllare sempre l'effettiva posizione dei kit a sospensione.
 The measure of the distance between the holes is indicative, always check the actual position of the suspension kits.

3

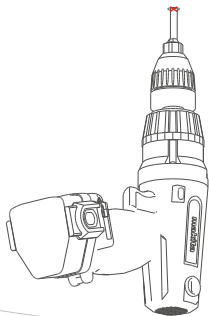

4

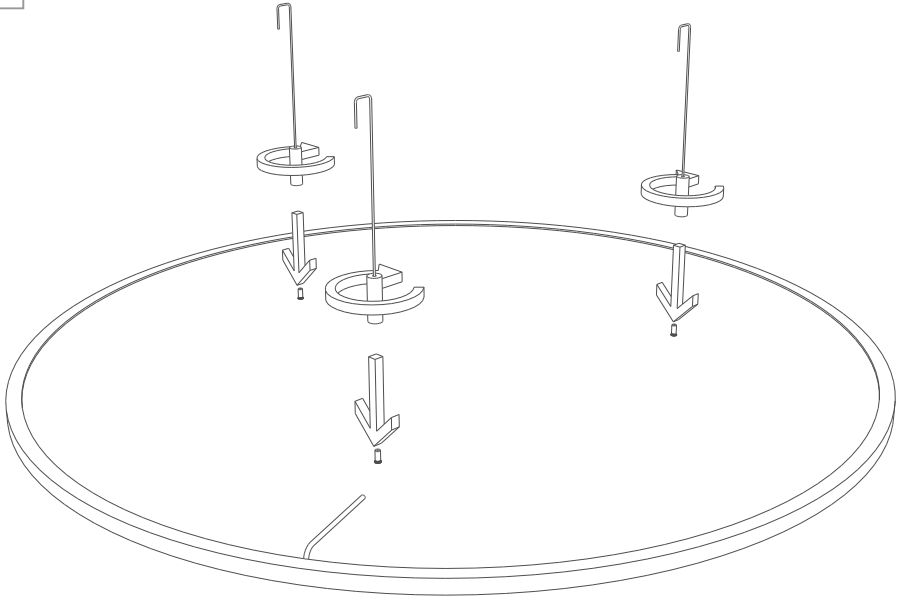

5

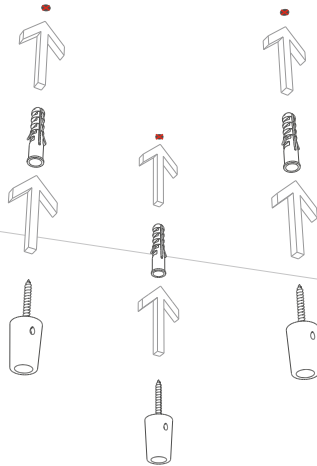

6

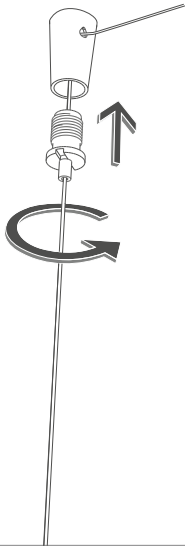

7

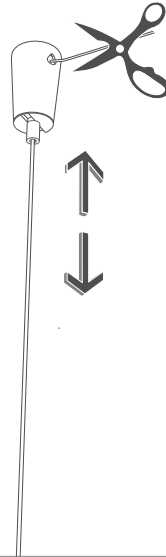

8

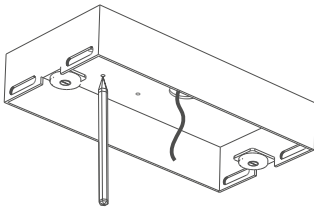

9

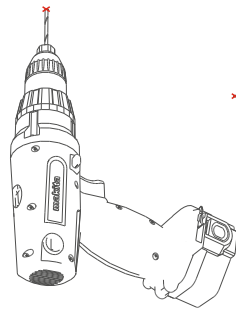

Rilevare gli interassi fra i fori di fissaggio del rosone.
Identify the distance between the fixing holes ceiling rose.

10

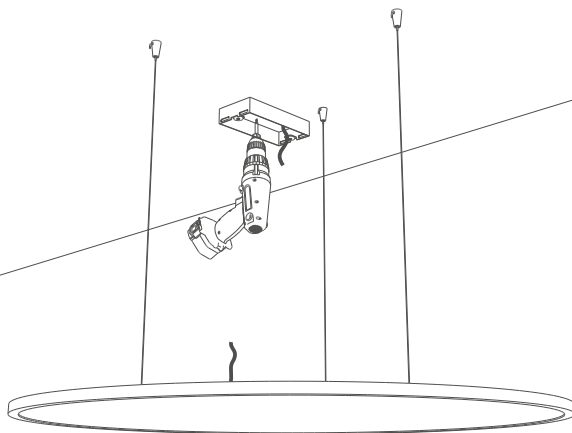

Fissare rosone a soffitto.
Fix the ceiling rose to the ceiling.

11

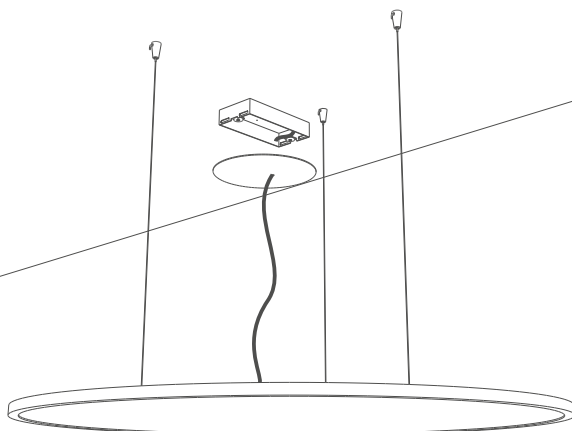

12b

Schema cablaggio alimentatore e dimmer 1..10V/PUSH.
Wiring pattern power supply and dimmer 1..10V/PUSH.

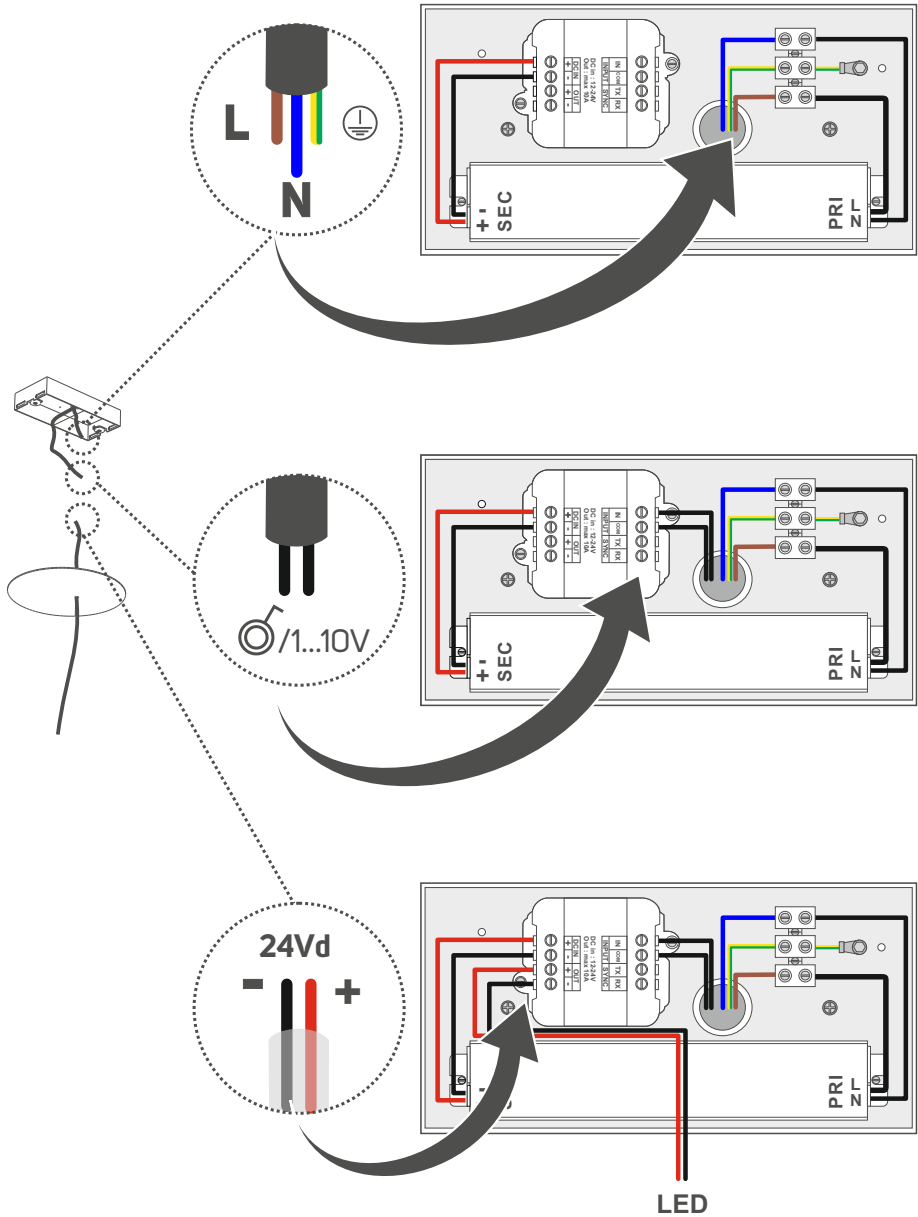

ATTENZIONE: Rispettare la polarità dei cavi
WARNING: Respect the polarity of the cables

12c

Schema cablaggio alimentatore e dimmer Dali.
Wiring pattern power supply and dimmer Dali.

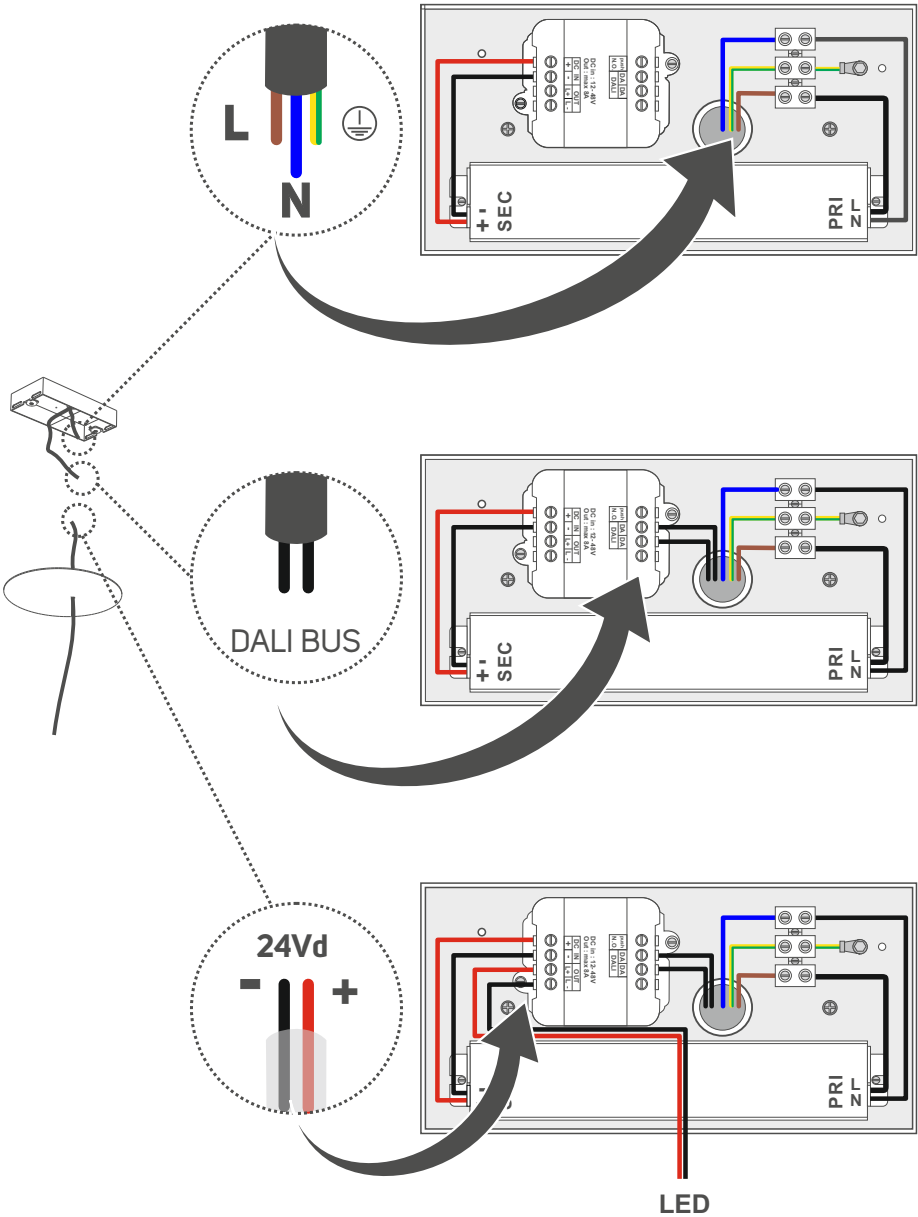

ATTENZIONE: Rispettare la polarità dei cavi
WARNING: Respect the polarity of the cables

12d

Schema cablaggio modalità MASTER/SLAVE valido per i dimmer 1..10V e PUSH.
MASTER/SLAVE wiring pattern valid for the 1..10V and PUSH dimmers.

Max 10 pz

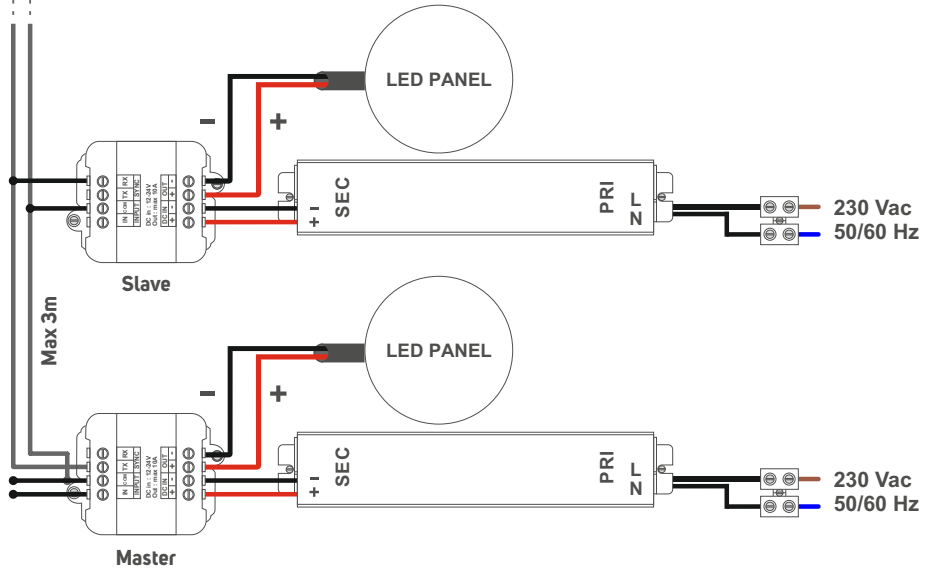

 **NON INCLUSI**
Not included

13

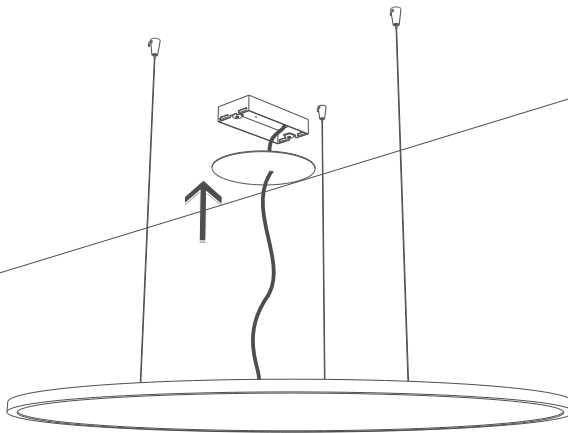

ATTENZIONE: PRIMA Verificare accensione profilo.
WARNING: FIRST Verify profile lighting.

